

# C&W Manufacturing and Sales Co.

# Parts Catalog

Providing the ultimate in design, efficiency and effectiveness since 1978.



Replacement parts for C&W and other manufacturers Dust Systems



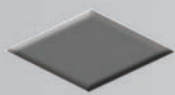

# Table of Contents:

Silo Saver System.....	1
AirMac.....	2
Forterra.....	3

## Dust Collector Components:

Air Fittings.....	4
Return Blower Components.....	5
Camlock Fittings.....	6
Door Handles and Door Parts.....	6
Ducting.....	7-9
Duct Packages, Flex, Angle Rings, Blast Gates.....	7
Spiral, Vent-a-Hood, Tape .....	8
Easy-UP Ducting (snaps-together).....	9-10
Electrical Timers.....	10
Fan and Fan Parts.....	11
Filter Media.....	12
Gauges.....	13
Shroud and Lift Frame Components.....	13
Valves.....	14

Replacement Parts Index.....	15
------------------------------	----

# Silo Saver System

## Anti-Overfill System

### Main Components



Bin Indicator -  
Bin Master w/ Extension



Dual Pressure Sensor



Broken Filter  
Media Detector



Overfill/Overpressure  
Control Panel



High Level Alarm

	PART #
Dual Pressure Switch	SW001
Broken Filter Media Detector	CW098
Bin Indicator - Bin Master w/ Extension	BI002
Overfill & Overpressure Control Panel	SS216
Overfill Control Panel, high level alarm	SS130
4" Anti-Overfill System	SS134
4" Pinch Valve	PV4-WM
Gasket for 4" Pinch Valve	GA000
5" Anti-Overfill System	SS135
5" Pinch Valve	PV5-WM
Gasket for 5" Pinch Valve	GA001
150 lb. Flange for Overfill System - 4"	FL003
150 lb. Flange for Overfill System - 5"	FL004
Bin Master Motor Unit Only	BI003



Anti-Overfill System  
available in 4" & 5"



150 Lb. Flange for Overfills  
Available in 4" & 5"



Pinch Valve  
available in 4" & 5"

### Accessory Components



Electrical  
Timer



Horn



Pinch Valve  
Bladder  
available in  
4" & 5"



Air Line  
Regulator

	PART #
Electrical Timers - 360-120-1-Sec	ET000
Horn used in Anti-Overfill Systems	EB087
Pinch Valve Bladder - 4"	PV4-BW
Pinch Valve Bladder - 5"	PV5-BW
Air Line Regulator, Preset to 55 PSI	AL010
1/4" (SB) Solenoid Valve w/ 6' cable	SO045
1/4" Solenoid Coil w/ Cable and Cord Grip	SO046
1/4" Air Muffler	AM000
Light Bulb (Old Style)	LT001
Light Bulb Strobe Element	LT002
Light Bulb Strobe - Red Lens	LT003
Light Bulb Strobe - Blue Lens	LT004
Light Bulb Strobe - Amber Lens	LT005



1/4" Solenoid Valve  
with 6' cable



1/4" Air  
Muffler



Light Bulb Strobe  
available in Red,  
Blue & Amber



Light bulb Strobe  
Element

## Material Handling Systems



Complete AirMac System  
(shown with Silencers)



Slide Gate  
available in 12" & 14"



Premier Blow-Through  
Box Round

AirMac™ System Parts	Part #
12" & 14" Slide Gates	Call C&W
Blow-Through Box	Call C&W
Bin Adapter	Call C&W
Vane Feeders	Part #
Rotary Vane Feeder 6 x 6 w/ Drive light - Light Duty DCS	RO001
Rotary Vane Feeder 8 x 8 w/ Drive - Hard Chrome Interior w/ Air Purge Kit	RO028-AP
Rotary Vane Feeder 10 x 10 w/ Drive - Hard Chrome Interior w/ Air Purge Kit	RO029-AP
12" Rotary Vane Feeder with 1 HP Drive 12"x12" rotary vane feeder features a hardened, chrome-plated, gray cast iron inner body, gray cast iron end plates, and a cast iron rotor with air purge kit.	RO030-AP
Rotary Vane Feeder 14 x 14 w/ Drive - Hard Chrome Interior w/ Air Purge Kit	RO031- AP
Rotary Vane Feeder 16 x 16 w/ Drive - Hard Chrome Interior w/ Air Purge Kit	RO032-AP

Note: Other Sizes are available for Vane Feeders, Call C&W for sizing and prices



Rotary Vane Feeder

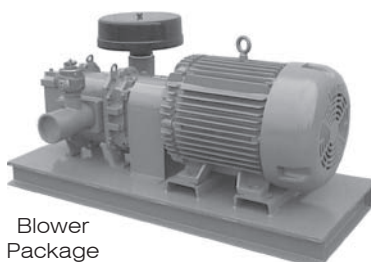

Blower  
Package

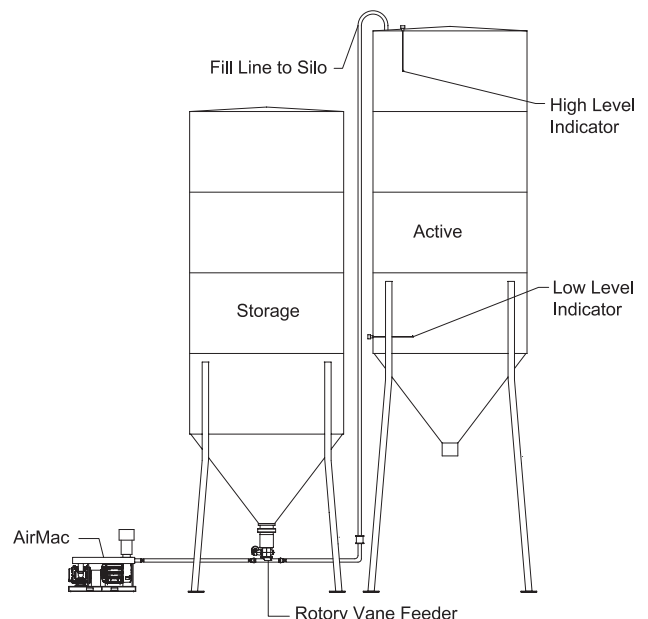

# Forterra System 3

## Concrete Reclaimer

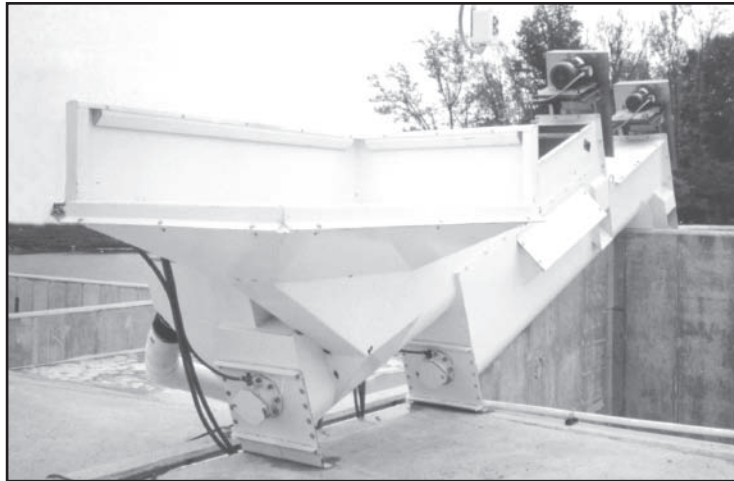
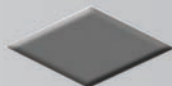

Unit is not longer for sale. Only replacement parts can be purchased.



Stainless Steel Perforated Plate



20" Aggregate Screw



3" Tail Shaft

Forterra System 3™ Parts	Part #
3 7/16" x 3" Tail Shaft w/ hardened steel ring set for 20" screw	JH002
3" Tail Shaft with hardened steel rings set for 16" screw	JH003
3" OD x 2 1/2" ID hardened steel ring set (5 per set)	JH004
3" Urethane Tail Bearing of both 16" and 20" screw	JH005
3/4" x 5 1/2" High-Strength Coupling Bolts (4 required for 16" screw)	JH006
7/8" x 5 1/2" High-Strength Coupling Bolts (4 required for 20" screw)	JH007
16" Sand Screw - Right Hand Flighting	SC050
16" Sand Screw - Left Hand Flighting	SC059
20" Aggregate Screw - Right Hand Flighting	SC049
20" Aggregate Screw -Left Hand Flighting	SC058
Stainless Steel Perforated Plate	JH010
Pond Filters - Nylon, Snap-In	JH019
Pond Filters - Burlap Bag	JH012



Pond Filter Nylon, Snap-In



3" OD x 2 1/2" ID hardened Steel Ring Set



3" Urethane Tail Bearing

# Air Fittings

## Air Hose, Check Valves, Relief Valves, Air Cylinders, Hose Clamps and Air Vibrators



Air Line Filter with Regulator



Air Line Regulator  
Preset to 55 PSI



Air Cylinder

Air Cylinder Parts	Part #
2 1/2" x 6" Air Cylinder	ACA001
Gas-Spring for lid on Modular Unit only	AC035
2 1/2" x 6" Repair Kit	AC002
6" x 18" Air Cylinder	AC017
8" x 18" Air Cylinder	AC003
8" x 24" Air Cylinder	AC001

Air Line Parts	Part #
Air Line Filter w/ Regulator	AL004
Air Line Regulator, Preset to 55 PSI	AL010
3/8" Air Hose- 200 PSI	H0008
3/8" Hose Clamp - "Air Hose Clamp"	HC006
Hose Clamps	Part #
2"-5" Hose Clamp	HC001
6"-10" Hose Clamp	HC003
14" Hose Clamp	HC005



1/4" Air Muffler



1/4" Air Muffler w/ Flow Control

Air Muffler Parts	Part #
1/4" Air Muffler	AM000
1/4" Air Muffler w/ Flow Control	AM002



"Push to Connect Air Fittings" are available in 1/4", 3/8", and 1/2" size for use with nylon, polyethylene, and polyurethane. Call C&W for pricing.

Air/Water Separator	Part #
Sun Ray Water Separator-71 CFM Capacity	FT004



Sun Ray Water Separator

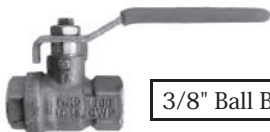

Ball Brass

3/8" Ball Brass	VA003
-----------------	-------



Weighted Pressure Relief Valve (Silo)



Swing Check Valve available in 2" & 3" (gravity fall)

Check Valves	Part #
2" Swing Check Valve (gravity fall)	CK001
3" Swing Check Valve (gravity fall)	CK002
Relief Valves	Part #
Weighted Pressure Relief Valve (Silo)	CW022
1"-12 PSI Relief Valve - Mercer	RV002



Vibco Vibrator (Small) 2-Bolt

Vibrators	Part #
Vibco Vibrator (small) 2-Bolt	VI005



Stand-Up Pressure Relief Valve - Mercer

# Return Blower Components

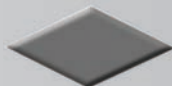

## Return Blowers and Parts, Drive Couplings and Return Hoses

Return Blowers and Parts	Part #
2" Return Blower Filter F8-108 (6 3/4" x 4")	RT021
3" Return Blower Filter F8-109 (10" x 5 1/4")	RT013
2" Return Blower Filter w/ Housing	RT019

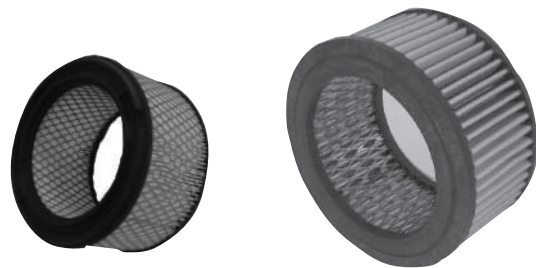

2" Return Blower Filter

3" Return Blower Filter

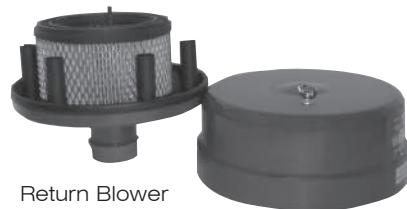

Return Blower Filter w/ Housing



Recycle Return Blower

Recycle Return Blower (Garner Denver/Sutorbilt)	RT020
---	-------



Small Diamond Pod for Cement Return System - 150 lbs.



Pod for Cement Return System - 250 lbs.

Sm. Diamond Return Pod for Return System -150#	01479
Pod for Cement Return System -250 #	01481



Cement Hose "Bull Hose"

Return Hoses	Part #
2" Cement Hose- "Bull Hose"	H0007
3" Cement Hose - "Bull Hose"	H0010
4" Cement Hose - "Bull Hose"	H0011
5" Cement Hose - "Bull Hose"	H0009
2"-5" Hose Clamp	HC001
Return Pipe	Part #
2" Half Nipple	PF093
3" Half Nipple	PF041
2" 180 degree Elbow	CW176
3" 180 degree Elbow	CW269
2" Pipe - Steel	ST200
3" Pipe - Steel	ST072

Synthetic Return Blower Oil (one quart)	OL000
---	-------



Couplings	Part #
3/4" 6JX Coupling	CP004
1 3/8" 6JX Coupling	CP001
Spider 6JE Coupling	CP003



Coupling



Spider Coupling

# Camlock Fittings

Camlock Fittings					
	2"	3"	4"	5"	6"
OC CamLock	CM015	CM001	CM006	CM010	CM021
Dust Cap	CM019	CM011	CM004	CM023	CM027
OF CamLock	CM014	CM003	CM007	CM024	N/A
KC Camlock	CM018	CM008	N/A	N/A	N/A
OA Camlock	CM016	CM000	CM005	CM017	CM020
OD Camlock	CM013	CM002	CM012	N/A	N/A



OC Camlock



Dust Cap



OD Camlock



KC Camlock



OA Camlock



OF Camlock

# Door Handles & Door Parts

Door Parts	Part #
"Hook" Style Door Handle, CP-Series	DO002
Rubber Door Trim (available in foot-long sections)	RB007
Rubber Door Seal for Hopper - Flat (available in foot long sections)	RB001
MCP Door Latch/Handle (used on the Modular units only)	DO007
MCP Door Limit Switch (used on the Modular units only)	EB199



Rubber Door Seal for Hopper- Flat



Rubber Door Trim

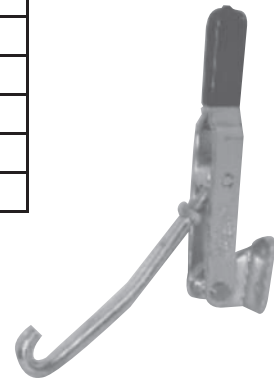

"Hook" Style Door Handle (CP Series)



# Ducting

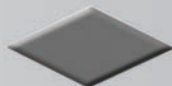

## Packages, Flex, Angle Rings and Blast Gates

Duct Packages	Part #		
	20 gauge	12 Gauge Heavy Duty	Easy-UP
30' of 14" Ducting for Mixer	DPSP14-001	DPHW14-001	DPSN14-001
30' of 14" Ducting for Shroud	DPSP14-002	DPHW14-002	DPSN14-002
30' of 16" Ducting for Mixer	DPSP16-001	Call C&W	DPSN16-001
30' of 16" Ducting for Shroud	DPSP16-002	DPHW16-001	DPSN16-002
8" Ducting to Single Silo (60')- 1 compartment	DPSP8-001	DPHW8-001	DPSN8-001
8" Ducting to Single Silo (60')- 2 compartments	DPSP8-002	DPHW8-002	DPSN8-002
8" Ducting to Two (2) Silos (60')- 2 compartments	DPSP8-003	DPHW8-003	DPSN8-003
10" Ducting to Single Silo (60')- 3 compartments	DPSP10-004	Call C&W	DPSN10-004
10" Ducting to Three (3) Silos (60')- 3 compartments	DPSP10-013	DPHW10-002	DPSN10-013
6" Ducting to Weigh Batcher	DPSP6-001	Call C&W	DPSN6-001

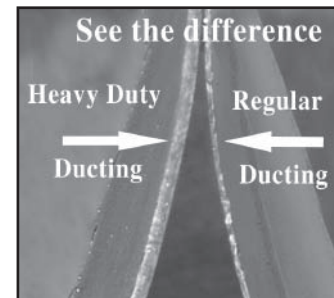

Blast Gate Assembly, Spiral	Part #
Blast Gate Assembly, 12" Single	CW047
Blast Gate Assembly, 14" Single	CW156
Blast Gate Assembly, 16" Single	CW187
Blast Gate Assembly, 14" Double	CW157
Blast Gate Assembly, 16" Double	CW188
Blast Gate Assembly, Easy-UP	Part #
Blast Gate Assembly, 12" Single	BG12
Blast Gate Assembly, 14" Single	BG14
Blast Gate Assembly, 16" Single	BG16
Blast Gate Assembly, 14" Double	BG14-D
Blast Gate Assembly, 16" Double	BG16-D



Flex Ducting

Flex Ducting available in 5 ft. increments only	Part #
4" Flex Ducting	H0000
6" Flex Ducting	H0001
8" Flex Ducting	H0002
10" Flex Ducting	H0003
12" Flex Ducting	H0004
14" Flex Ducting	H0005
16" Flex Ducting	H0006
6"-10" Hose Clamp	HC003
14" Hose Clamp	HC005

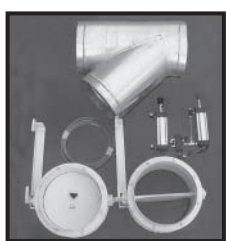

Blast Gate Assembly  
14" & 16" Double

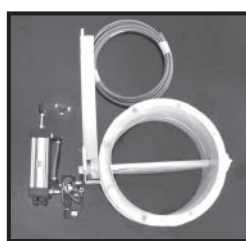

Blast Gate Assembly  
14" Single

Silo Collector Cover Plate	Part #
Silo Collector Cover Plate (seals hole when removing a silo collector)	COVER-PLATE-001

Blast Gates, Steel	Part #
Blast Gate, 14" Normally Open	01559
Blast Gate, 14" Normally Closed	01161
Blast Gate, 16" Normally Open	01557
Blast Gate, 16" Normally Closed	01547
Blast Gates, Aluminum	Part #
Blast Gate, 6"	BS001
Available in Manual & Pneumatic Available in other sizes, call C&W	



Steel Blast Gate

Angle Rings	Part #
4" Angle Ring	AN000
6" Angle Ring	AN001
8" Angle Ring	AN002
10" Angle Ring	AN003
12" Angle Ring	AN004
14" Angle Ring	AN005
16" Angle Ring	AN006
18" Angle Ring	AN007
20" Angle Ring	AN008



Angle Ring

# Ducting

## Spiral Duct Fittings, Vent-a-Hood & Slide Gate

Spiral Duct Fittings	Part #	
	20 Gauge	12 Gauge Heavy Duty
10" Bell Mouth	SP234	N/A
12" Bell Mouth	SP233	N/A
6" 45 Degree Fittings	SP010	SP202
8" 45 Degree Fittings	SP011	SP188
10" 45 Degree Fittings	SP012	SP184
12" 45 Degree Fittings	SP013	SP213
14" 45 Degree Fittings	SP014	SP192
16" 45 Degree Fittings	SP015	SP214
6" 90 Degree Fittings	SP019	SP203
8" 90 Degree Fittings	SP020	SP189
10" 90 Degree Fittings	SP021	SP185
12" 90 Degree Fittings	SP022	SP232
14" 90 Degree Fittings	SP023	SP191
16" 90 Degree Fittings	SP024	SP216
8" 180 Degree Fittings	SP040	SP190
6" Field Coupling	SP028	N/A
8" Field Coupling	SP029	N/A
10" Field Coupling	SP030	N/A
12" Field Coupling	SP031	N/A
14" Field Coupling	SP032	N/A
16" Field Coupling	SP033	N/A
10 x 8 Reducer	SP046	N/A
14 x10 Reducer	SP050	N/A
14 x12 Reducer	SP036	N/A
16 x14 Reducer	SP124	SP218
8 x 8 x 6 Transitions	SP037	N/A
8 x 8 x 8 Transitions	SP054	SP187
10 x 8 x 6 Transitions	SP055	SP205
14x 14x 8 Transitions	SP070	SP209
14x 14x 10 Transitions	SP071	SP204
14x 14x14 Transitions	SP038	SP200
16x 14x 14 Transitions	SP090	SP223
16x 12x 12 Transitions	SP118	N/A
14x 14x 14 "Y" Transitions	SP073	N/A

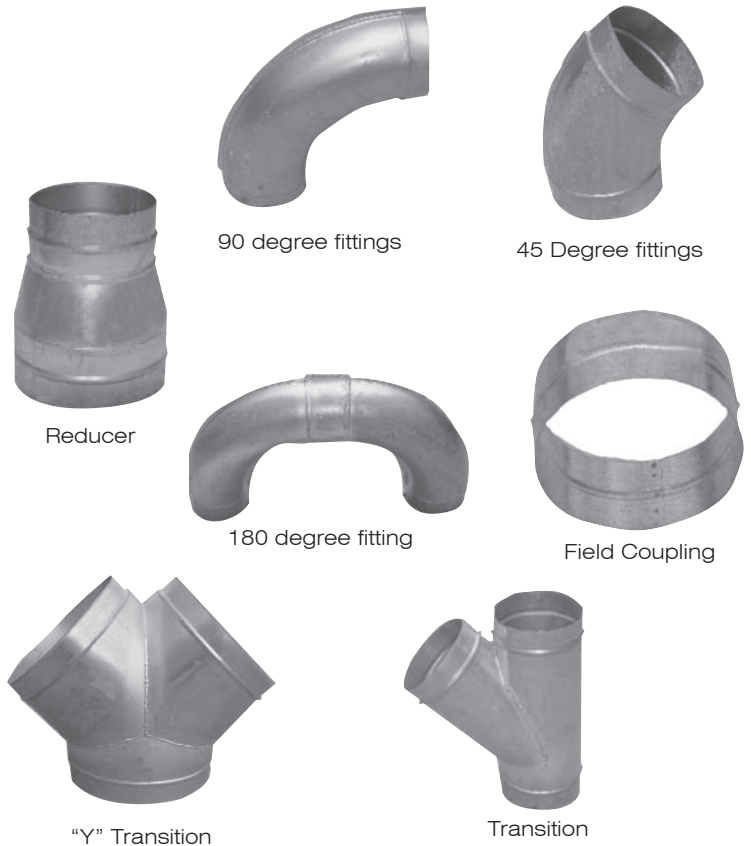

Ducting Tape	Part #
3" Aluma Grip Duct Tape	T0002



Aluma Grip Duct Tape



Vent-a-Hood

Vent-a-Hood	Part #
6" Vent-a-Hood	VE000

Aluminum Slide Gate	Part #
12" Aluminum Slide Gate	BS004
14" Aluminum Slide Gate	BS005

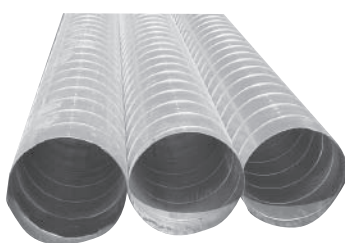

Spiral Steel Duct  
20 gauge

Spiral Steel Duct (20 Gauge) available in 10 ft. Increments only	Part #
6" 20 gauge Spiral Ducting	SP001
8" 20 gauge Spiral Ducting	SP002
10" 20 gauge Spiral Ducting	SP003
12" 20 gauge Spiral Ducting	SP004
14" 20 gauge Spiral Ducting	SP005
16" 20 gauge Spiral Ducting	SP006

# Ducting

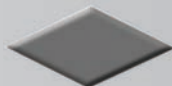

## Easy-UP Ducting - Continued on Next Page

Easy-UP Duct Fittings	Part #
PIPE 6" x 59.25" LONG	SNAP06000
ADJ NIPPLE WITH O-RING 6"	SNAP06100
ELBOW 6" 90 Deg. 1.0CLR	SNAP06200
ELBOW 6" 45 Deg. 1.0CLR	SNAP06300
HOSE ADAPTER 6"	SNAP06400
ANGLE FLANGE ADAPTER 6"	SNAP06500
CLAMP WITH PIN 6"	SNAP06600
PIPE HANGER 6"	SNAP06700
BRANCH, A=06 B=06 C=06	SNAP06800
PIPE 8" x 59.06" LONG	SNAP08000
ADJ NIPPLE WITH O-RING 8"	SNAP08100
ELBOW 8" 90 Deg. 1.5CLR	SNAP08200
ELBOW 8" 45 Deg. 1.5CLR	SNAP08300
HOSE ADAPTER 8"	SNAP08400
ANGLE FLANGE ADAPTER 8"	SNAP08500
CLAMP WITH PIN 8"	SNAP08600
PIPE HANGER 8"	SNAP08700
BRANCH, A=08 B=06 C=08	SNAP08800
BRANCH, A=08 B=08 C=08	SNAP08850
REDUCER, A=08 B=06	SNAP08900
PIPE 10" x 59.06" LONG	SNAP10000
ADJ NIPPLE WITH O-RING 10"	SNAP10100
ELBOW 10" 90 Deg. 1.5CLR	SNAP10200
ELBOW 10" 45 Deg. 1.5CLR	SNAP10300
HOSE ADAPTER 10"	SNAP10400
ANGLE FLANGE ADAPTER 10"	SNAP10500
CLAMP WITH PIN 10"	SNAP10600
PIPE HANGER 10"	SNAP10700
BRANCH, A=10 B=06 C=08	SNAP10800
BRANCH, A=10 B=08 C=08	SNAP10810
BRANCH, A=10 B=08 C=10	SNAP10820
BRANCH, A=10 B=10 C=10	SNAP10830
BRANCH, A=10 B=06 C=10	SNAP10850
REDUCER, A=10 B=08	SNAP10900
PIPE 12" x 58.75" LONG	SNAP12000
ADJ NIPPLE WITH O-RING 12"	SNAP12100
ELBOW 12" 90 Deg. 1.5CLR	SNAP12200
ELBOW 12" 45 Deg. 1.5CLR	SNAP12300
HOSE ADAPTER 12"	SNAP12400
ANGLE FLANGE ADAPTER 12"	SNAP12500
CLAMP WITH PIN 12"	SNAP12600
PIPE HANGER 12"	SNAP12700
BRANCH, A=12 B=08 C=10	SNAP12800
BRANCH, A=12 B=10 C=08	SNAP12810
BRANCH, A=12 B=10 C=10	SNAP12820

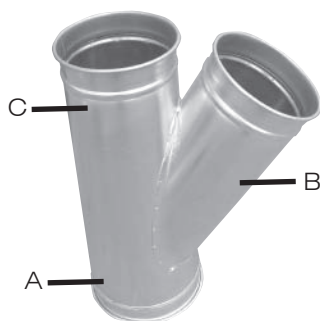

Branch ("Y" Transition)

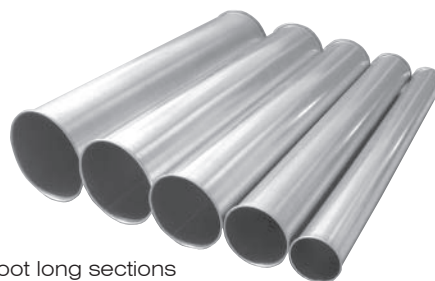

5 foot long sections Available in 6" and up



45 Degree Transition Available in 6" and up



Clamp-Together Fitting w/ Pin, Available in all Sizes



Angle Ring Adapter



45 Degree Elbow



90 Degree Fitting



Y-Branch



Adjustable Nipple w/ "O" Ring

Easy-UP Duct Fittings	Part #
PIPE 14" x 58.75" LONG	SNAP14000
ADJ NIPPLE WITH O-RING 14"	SNAP14100
ELBOW 14" 90 Deg. 1.5CLR	SNAP14200
ELBOW 14" 45 Deg. 1.4CLR	SNAP14300
HOSE ADAPTER 14"	SNAP14400
ANGLE FLANGE ADAPTER 14"	SNAP14500
CLAMP WITH PIN 14"	SNAP14600
PIPE HANGER 14"	SNAP14700
BRANCH, A=14 B=06 C=14	SNAP14800
BRANCH, A=14 B=08 C=14	SNAP14810
BRANCH, A=14 B=14 C=14	SNAP14820
BRANCH, A=14 B=10 C=10	SNAP14830
BRANCH, A=14 B=12 C=12	SNAP14840
BRANCH, A=14 B=10 C=14	SNAP14850
Y-BRANCH, A=14 B=14 D=14	SNAP14860

# Ducting Cont.

## Easy-UP Ducting Cont.

Easy-UP Duct Fittings	Part #
PIPE 16" x 58.75" LONG	SNAP16000
ADJ NIPPLE WITH O-RING 16"	SNAP16100
ELBOW 16" 90 Deg. 1.5CLR	SNAP16200
ELBOW 16" 45 Deg. 1.5CLR	SNAP16300
HOSE ADAPTER 16"	SNAP16400
ANGLE FLANGE ADAPTER 16"	SNAP16500
CLAMP WITH PIN 16"	SNAP16600
PIPE HANGER 16"	SNAP16700
BRANCH, A=16 B=16 C=16	SNAP16800
BRANCH, A=16 B=14 C=14	SNAP16810
BRANCH, A=16 B=10 C=14	SNAP16820
BRANCH, A=16, B=12, C=12	SNAP16830
REDUCER, A=16 B=14	SNAP16900



90 Degree Elbow  
Available in 6" and up



Clamp-Together  
Fitting w/ Pin,  
Available in all Sizes

Call C&W For Pricing on Sizes 18" and Up

# Electrical Timers

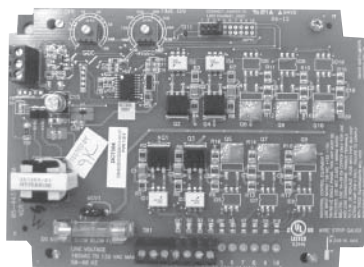

Dwyer Electric Board  
For Silo Collectors

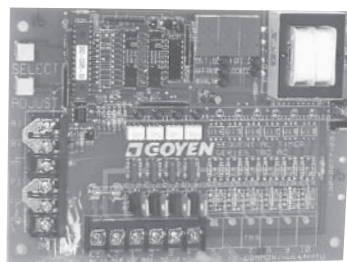

Goyen Digital Timer  
For Central & Silo Collectors



360-120-1 Minute  
Timer



368-120-1 Sec.  
Electrical timer

Electrical Timers	Part #
360-120-1 - Second 8 Pin, T2	ET000
360-120-1 - Minute 8 Pin, T1 & T3	ET001
361-120-1 - Second	ET002
TM 261S-120 - 2 Stage Alternator 8 Pin Relay	ET003
120 Volt Relay-8501 KPIZV	ET004
368-120-1 - Second (Double Timer) 8 Pin, T4	ET006
Goyen 4 Pole Time Board 12 V	ET010
361-120-1 Minute Timer	ET011
4 Pole Digital Timer Board - Goyen (For Silo)	ET025
6 Pole Digital Timer Board - Goyen (For Central)	ET026
8 Pole Digital Timer Board - Goyen (For Central)	ET027
10 Pole Digital Timer Board - Goyen (For Central)	ET028
4 Pole Non-Digital Board - Dwyer (For Silo)	ET039
E/T Socket 8 Pin	ET012



120 Volt Relay



Alternator

# Fans & Fan Parts

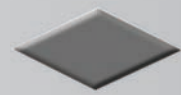

Cincinnati Direct Drive Fans	Part #
PB-12 w/ 2 HP 650 CFM Fan	CW083
HDBI-120-70% w/ 3 HP 2000 CFM Fan	BL059
HDBI-120-75% w/ 3 HP 1600 CFM @ 6" Fan	BL055
HDBI-120-95% w/ 3 HP 2000 CFM Fan	BL060
HDBI-120-100% w/ 5 HP 2200 CFM @ 6" Fan	BL077
HDBI-130-65% w/ 5 HP 2500 CFM Fan	BL053
HDBI-130-75% w/ 5 HP 2500 CFM Fan	BL061
HDBI-130-80% w/ 5 HP 2000 CFM @ 8" Fan	BL003
HDBI-130-85% w/ 5 HP 2200 CFM @ 8" Fan	BL078
HDBI-130-95% w/ 5 HP 3000 CFM Fan	BL062
HDBI-150-75% w/ 7.5HP 3000 CFM Fan	BL063
HDBI-150-85% w/ 7.5HP 4000 CFM Fan	BL064
HDBI-150-95% w/ 10HP 4000 CFM @ 8" Fan	BL004
HDBI-160-70% w/ 10HP 4500 CFM Fan	BL074
HDBI-160-75% w/ 10HP 4500 CFM Fan	BL065
HDBI-160-85% w/ 15HP 5000 CFM @ 8" Fan	BL069
HDBI-240-60% w/ 7.5HP 5500 CFM Fan	BL067
HDBI-160-85% w/ 10HP 5000 CFM Fan	BL066
Fan Drive Belts	
3VX-750 Belt	BE026
3VX-850 Belt	BE024
3VX-900 Belt	BE025
3VX-950 Belt	BE011
3VX-1000 Belt	BE027
5VX-1120 Belt	BE017
Fan Bearings	
4 Bearing, Flange 1 11/16" Link Belt	BR002
4 Bearing, Flange 1 7/16" Link Belt	BR003

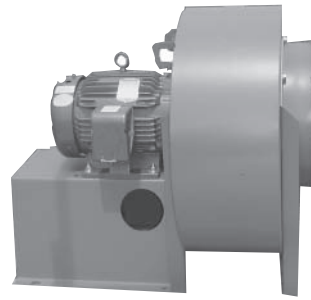

Fan



Northern Wheel

Northern Fan and Fan Parts	Part #
Northern 18 1/4" Fan	BL052
Northern 20" Fan	BL050
Northern 22 1/4" Fan	BL051
Northern 24" Fan	BL070
Northern 27" Fan	BL097
Northern 30" Fan	BL101
Shaft 18 1/4" (Northern)	BL009
Shaft 20" (Northern)	BL079
Shaft 22 1/4" (Northern)	BL118
Wheel 18 1/4" (Northern)	BL072
Wheel 20" (Northern)	BL073
Wheel 22 1/4" (Northern)	BL119
Inlet Cone 18 1/4" (Northern)	BL013
Inlet Cone 20" (Northern)	BL007
Inlet Cone 22 1/4" (Northern)	Call C&W
Bearing Mount Plate 18 1/4"	BL115
Bearing Mount Plate 20"	BL116
Bearing Mount Plate 22 1/4"	BL117
Chicago Fan and Fan Parts	
SQB 16 1/2" Fan (Chicago)	BL000
SQB 18 1/4" Fan (Chicago)	BL005
SQB 20" Fan (Chicago)	BL006
SQB 16 1/2" Wheel (Chicago)	BL027
SQB 18 1/4" Wheel (Chicago)	BL028
SQB 20" Wheel (Chicago)	BL029
Shaft 16 1/2" Fan (Chicago)	BL021
Shaft 18 1/4" Fan (Chicago)	BL022
Shaft 20" Fan (Chicago)	BL023
Shaft 22 1/4" Fan (Chicago)	BL024
Bearing Mount 16 1/2", 20" Fan (Chicago)	BL011
Inlet Cone 16 1/2" (Chicago)	BL043
Inlet Cone 18 1/4" (Chicago)	BL034
Inlet Cone 20" (Chicago)	BL042
Inlet Cone 22 1/4" (Chicago)	BL018



4 Bolt, Flange Bearing



SQB Fan



Inlet Cone

# Filter Media

Includes all Bags, Cartridges and Cages

Filter Media	Part #
<b>Bags (for RA and BP units)</b>	
6" x 5' Bags for BP	B0007
6" x 10' Bags for BP	B0006
Cage with venturi for 6" x 5' Bags for BP	B0008
Cage with venturi for 6" x 10' Bags for BP	B0005
8" x 114" Bags for RA	B0001
8" x 69" Bags - Old Style RA units	B0000
8" x 138" Bags for RA-170 & RA-340	B0011
4" x 78" Bags- Silo Shaker SK250	B0014
<b>Cartridges (for CP units)</b>	
12 3/4" x 27" Cartridge (CP-100)	CD002
8" x 19" Cartridge (CP-35 & CP-70)	CD000
8" x 39" Cartridge	CD012
8" x 54" Cartridge	CD007
8" x 54" Cartridge (88 pleats for Modular unit)	CD017
Heavy Duty 8"x78" Cartridge w/ molded ends (sf)	CD011



Bags for BP Collector  
(8" Diameter)



Bags for Reverse Air and Silo Shaker  
(8" Diameter)



Cage with Venturi for Bags in the  
BP Collector



12 3/4" x 27"  
Cartridge for CP 100  
Collector



Varied Cartridges for  
CP Collector  
(8" Diameter)  
(Shown in 78", 54"  
and 39")



Bag Hanger Hook

	Part #
1/4" x 2" Bag Hanger Hook	BT011

## C&W's Filter Cartridge Warranty:

CP Series filters sold by C&W that fail to workmanship or material defect are subject to the following pro-rated warranty:

1. Filter Failure that occurs from 0-6 months from the date of purchase will be replaced at no charge.
2. Filter failure that occurs from 6-9 months from date of purchase will be replaced with a 50% discount off the customer's cost for a new filter.
3. Filter failure that occurs from 9-12 months from date of purchase will be replaced with a 25% discount off the customers' cost for a new filter.
4. Filter failure that occurs from 12-15 months from date of purchase will be replaced with a 15% discount off the customer's cost for a new filter.

\*Filters that are crushed or have not been supplied with clean, dry air @ 100 PSI are not subject to warranty.

# Gauges

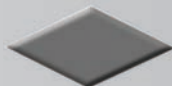

## Gauges, Hoses, and Hose Clamps



Magnehelic Gauge - 4"

Gauges	Part #
#2020 Magnehelic Gauge	MA013
"Mini" Helic Magnehelic Gauge	MA014
3/16" Clear Vinyl Hose for Magnehelic Gauge	H0012



"Mini" Helic Magnehelic Gauge - 2"

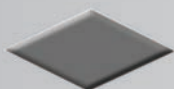

## Shroud and Lift Frame Components

Cable	Part #
5/16" 7 x 19 Cable	CB002
Cable Clamp 1/8"	CB003
Cable Clamp 5/16"	CB006



Cable Clamp



2 Bolt,  
Pillow Block

Shroud Bearings	Part #
2 Bolt, Pillow Block 1"	BR008
2 Bolt, Pillow Block 1 1/4"	BR013

Chains	Part #
5/16" x 1 1/2" System 3 Proof Coil Chain	CH000
Lap Link 5/16" x 1 1/2" Chain	CH001
"D" Link- 5/16" Quick Link Chain	CH004



Lap Link chain



System 3 Proof  
Coil Chain



"D" Link  
Quick Link Chain



Pulleys	Part #
Sheave, Standard 5/16"	CB007
Sheave, Heavy Duty	CB001
Sheave, Steel w/ Brushing	CB004

Curtains (Shroud Curtain Material)	Part #
Shroud- Canvas 155" Curtain	CR001
Shroud- Canvas 176" TML Curtain	CW224
Shroud- Canvas 191" TMEL 5 Panel Curtain	CW225
2" Steel Channel Ring Assembly- 176" or 191"	CW089
Rubber Belting 60" PVC 90 for Shrouds	RB005

## Electrical (Solenoid) and Butterfly



Double Bulkhead



Solenoid Valve



Din Cord



1/4" Solenoid Valve with 6' cable

Solenoid Valves	Part #
3/4" Solenoid Valve	S0026
1" Solenoid Valve	S0002
1 1/2" Solenoid Valve	S0010
1" Goyen Millennium Solenoid Valve - used with Modular unit ONLY	S0007
3/4" and 1" Solenoid Repair Kit (ASCO)	S0004
3/4" Double Bulkhead (MID)	S0012
1" Double Bulkhead (MID)	S0014
1 1/2" Double Bulkhead	S0025
3/4" Solenoid Valve for CP-35	S0008
1/4" Solenoid Valve (SB)	S0017
1/4" Solenoid Valve with 6' cable and steel cord grip	S0045
Inching Solenoid Valve (SB) - for Lift Frames	S0020
Coil for 3/4", 1" and 1 1/2" Solenoid	S0033
Turbo 3/4" and 1" Diaphragm Repair Kit	S0030
Turbo 1 1/2" Diaphragm Repair Kit	S0031
3' Din Cord - E/W Solenoid Connector	EW015
6' Din Cord - E/W Solenoid Connector	EW016

Helpful Hint: Turbo's can replace ASCO's.



Inching Solenoid Valve

Butterfly Valves and Parts	Part #
Bray 6" Butterfly Valve	BF004
Bray 8" Butterfly Valve	BF001
Bray 6" Butterfly Valve Actuator	BF007
Bray 8" Butterfly Valve Actuator	BF003
Bray 8" Butterfly Adapter	BF002
Bray Manual Lever Butterfly Valve	BF008
WAM 6" Butterfly Valve	BF005
WAM 8" Butterfly Valve	BF006
WAM Butterfly Valve Actuator	BF009

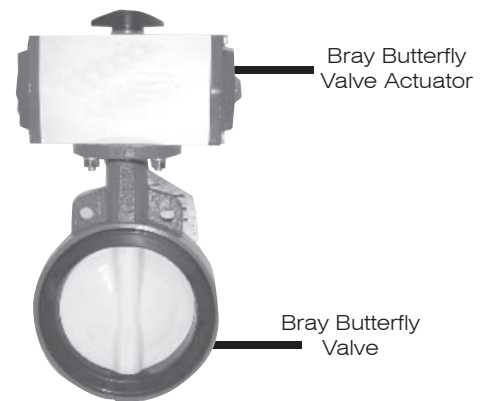

Bray Butterfly Valve Actuator

Bray Butterfly Valve

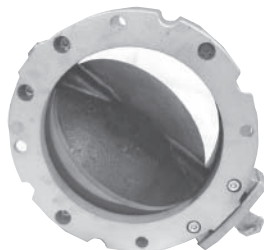

WAM Butterfly Valve



WAM Butterfly Valve Actuator



# Replacement Parts Index

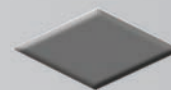

Air Cylinder.....	4
Air Line Parts.....	4
AirMac System - Parts and Vane Feeders.....	2
Air Mufflers.....	1&4
Air/Water Separator.....	4
Angle Rings.....	7
Blastgates - Assembly, Steel, Aluminum.....	7
Blowers - Recycle Return Blowers, Parts, Filters, Return Hoses & Pipes.....	5
Cable - for Shrouds and Lift frames.....	13
Camlock Fittings.....	6
Chains - for Shrouds and Lift frames.....	13
Curtains - Shroud Curtain Material.....	13
Concrete Reclaimer - Forterra System 3™ Parts.....	3
Door Handles and Parts - Door Trim, Rubber.....	6
Ducting Packages - 20 gauge, 12 gauge, and Easy-UP.....	7
Ducting - Flex, Spiral, Tape.....	7-8
Ducting - Easy-UP.....	9-10
Electrical Timers.....	10
Fans - Chicago, Cincinnati, HBDI, Bearings, Drive Belts.....	11
Filter Media - for BP, CP, and RA units.....	12
Gauges.....	13
Pulleys.....	13
Shroud Bearings.....	13
Slide Gate - aluminum.....	8
Valves - Check, Relief.....	4
Valves - Solenoid, Butterfly.....	14
Vane Feeders.....	2
Vibrators.....	4

# Consider C&W's AirMac Transfer System

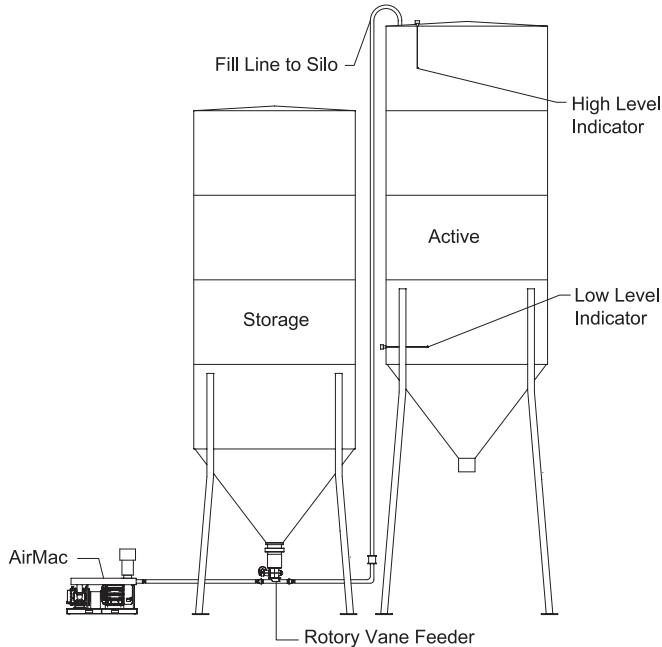

**Systems Available to Transfer Material up to 100 Tons per Hour**



**Rotary Vane Feeder**

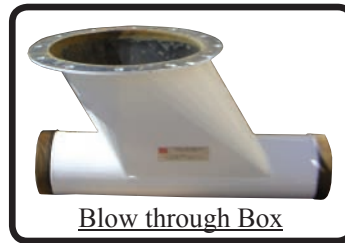

**Blow through Box**



**Emergency Slide Gate**

#### AMDD BLOWER PACKAGE

Includes all the standard equipment of the AirMac blower package, including motor/blower, direct drive, inlet filter, check and relief valves, pressure gauge, and the steel base.

#### Rotary Vane Feeder

Rotary vane feeder features a hardened, chrome-plated, gray cast iron inner body, gray cast iron end plates, and a cast iron rotor with tips. (Size based on desired material transfer rate) Air Purge System included for longer bearing life.

#### ADJUSTABLE SLIDE GATE

Slide gate features a wheel handle with ball bearings for adjustment. Constructed of steel c-channel.

#### BLOW-THROUGH BOX

Allows efficient transfer of material from the rotary vane feeder into the transfer line. Includes all necessary mounting hardware.

#### ELECTRICAL CONTROL PANEL

Available for 220V or 440V, our control panel is housed in a NEMA 3R weatherproof cabinet. It features a main fused quick disconnect, transformer, sequential timers, and manual push button controls. In addition, it has a motor starter, fuses, and overload heaters.

#### BIN ADAPTER

The AirMac system includes a bin adapter to mount on an existing or new storage silo. Every adapter is custom-designed to customer specifications.

#### BIN INDICATORS

Two solid-state probe-type bin indicators for high and low level material measurement. Features NEM 4 enclosure, potted electronics, time delay settings, and 3' long steel rod.

#### TRANSFER LINE

14' of heavy-duty pneumatic transfer hose with fittings provided between blower and blow-through box.

#### OPERATION

System is designed to automatically transfer material from day silo to an active silo via signals received from the high and low level bin indicators.

# Easy-UP Ducting

A Premiere Snap-together ducting system



- 30% less labor & 30% less downtime for installation.
- Easily and quickly installed; simply clamp-together. No rivets, screws, or welding needed.
- Adaptable to existing duct work & Reusable.
- Easy to clean-out. Sections are easy to remove, clean-out and replace.
- Available in galvanized steel.

Easy-UP duct was designed with user-friendliness and ease of installation in mind. Easy-UP duct features a snap-together ducting system which eliminates rivets, screws, welds, and other time-consuming joining methods. Easy-UP duct has the latest technology in laser welding which creates stronger, air-tight, seams that provide smooth, no hang-up interiors.

